

## Rozł czniki 0-1

**1.4213** Rozł cznik 0-1 (1 - biegunowy)

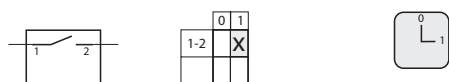

**1.825** Rozł cznik 0-1 (1 - biegunowy)

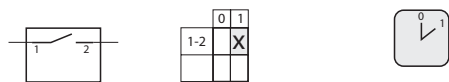

**1.428** Rozł cznik 0-1 (2 - biegunowy)

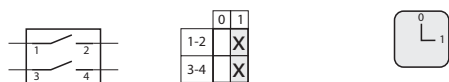

**1.828** Rozł cznik 0-1 (2 - biegunowy)

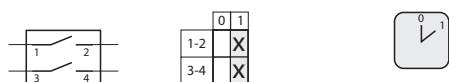

**2.8211** Rozł cznik 0-1 (3 - biegunowy)

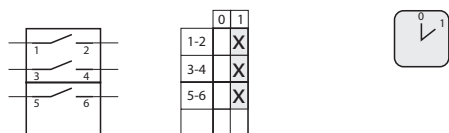

**2.423** Rozł cznik 0-1 (3 - biegunowy)

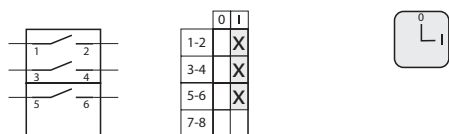

**2.4226** Rozł cznik 0-1 (4 - biegunowy)

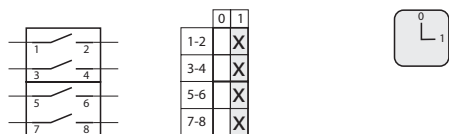

**2.8210** Rozł cznik 0-1 (4 - biegunowy)

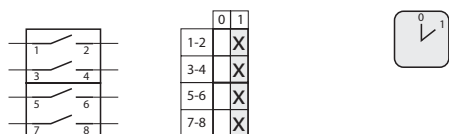

**3.8220** Rozł cznik 0-1 (5 - biegunowy)

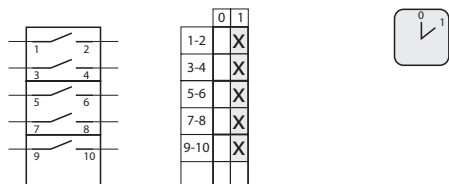

**3.8210** Rozł cznik 0-1 (6 - biegunowy)

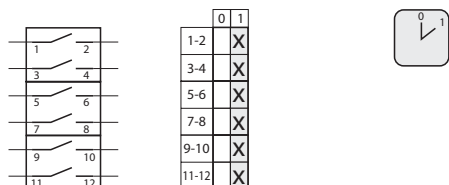

**4.8240** Rozł cznik 0-1 (7 - biegunowy)

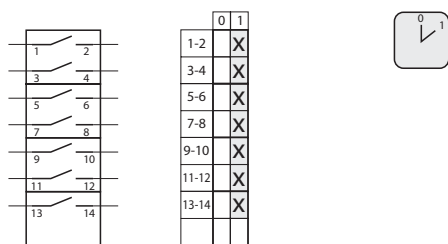

**4.824** Rozł cznik 0-1 (8 - biegunowy)

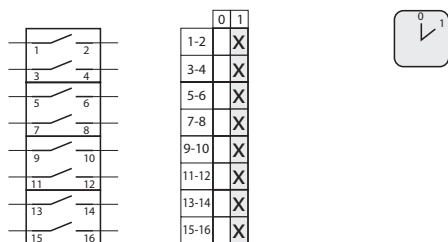

**5.8220** Rozł cznik 0-1 (9 - biegunowy)

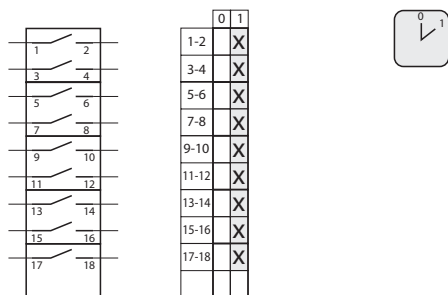

**5.822** Rozł cznik 0-1 (10 - biegunowy)

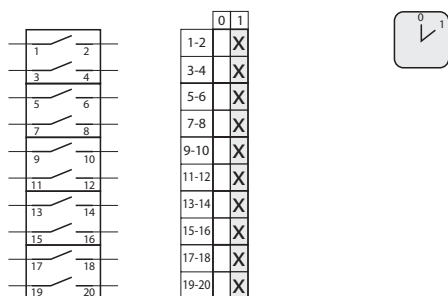

**6.8210** Rozł cznik 0-1 (11 - biegunowy)

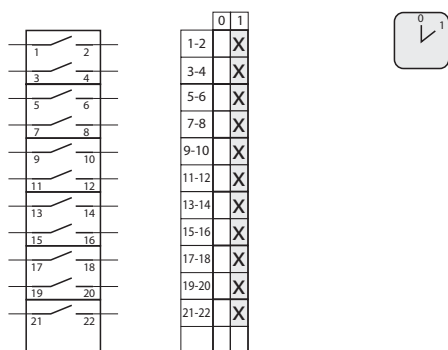

**6.821** Rozł cznik 0-1 (12 - biegunowy)

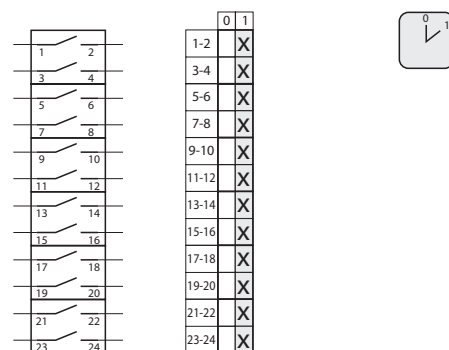

**7.8220** Rozł cznik 0-1 (13 - biegunowy)

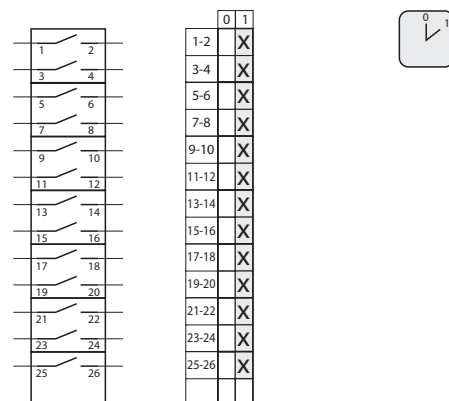

**7.822** Rozł cznik 0-1 (14 - biegunowy)

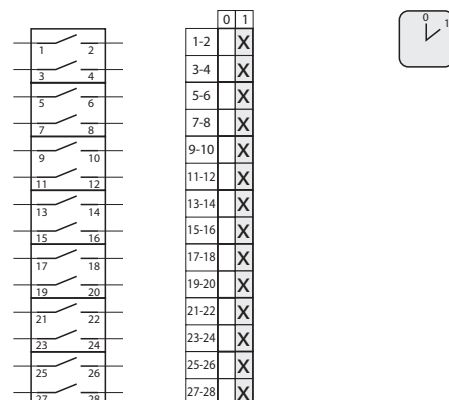

**8.8270** Rozł cznik 0-1 (15 - biegunowy)

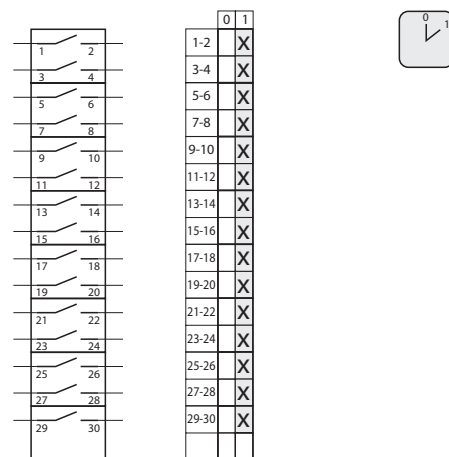

## 8.827 Rozł cznik 0-1 (16- biegunowy)

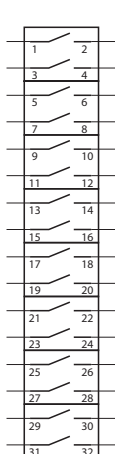

	0	1
1-2	X	
3-4	X	
5-6	X	
7-8	X	
9-10	X	
11-12	X	
13-14	X	
15-16	X	
17-18	X	
19-20	X	
21-22	X	
23-24	X	
25-26	X	
27-28	X	
29-30	X	
31-32	X	



## 10.8210 Rozł cznik 0-1 (19 - biegunowy)

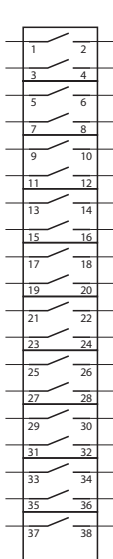

	0	1
1-2	X	
3-4	X	
5-6	X	
7-8	X	
9-10	X	
11-12	X	
13-14	X	
15-16	X	
17-18	X	
19-20	X	
21-22	X	
23-24	X	
25-26	X	
27-28	X	
29-30	X	
31-32	X	
33-34	X	
35-36	X	
37-38	X	



## 9.8210 Rozł cznik 0-1 (17 - biegunowy)

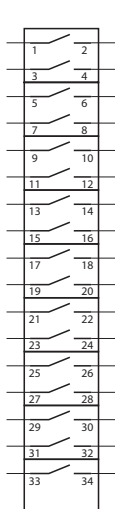

	0	1
1-2	X	
3-4	X	
5-6	X	
7-8	X	
9-10	X	
11-12	X	
13-14	X	
15-16	X	
17-18	X	
19-20	X	
21-22	X	
23-24	X	
25-26	X	
27-28	X	
29-30	X	
31-32	X	
33-34	X	



## 10.821 Rozł cznik 0-1 (20 - biegunowy)

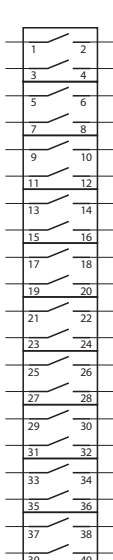

	0	1
1-2	X	
3-4	X	
5-6	X	
7-8	X	
9-10	X	
11-12	X	
13-14	X	
15-16	X	
17-18	X	
19-20	X	
21-22	X	
23-24	X	
25-26	X	
27-28	X	
29-30	X	
31-32	X	
33-34	X	
35-36	X	
37-38	X	
39-40	X	



## 9.821 Rozł cznik 0-1 (18 - biegunowy)

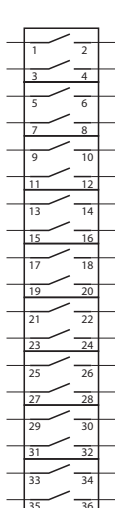

	0	1
1-2	X	
3-4	X	
5-6	X	
7-8	X	
9-10	X	
11-12	X	
13-14	X	
15-16	X	
17-18	X	
19-20	X	
21-22	X	
23-24	X	
25-26	X	
27-28	X	
29-30	X	
31-32	X	
33-34	X	
35-36	X	



## Rozł czniki 1 - 0 - 2

### 1.834 Rozł cznik 1-0-2 (1 - biegunowy)

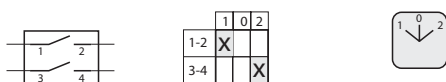

### 2.8338 Rozł cznik 1-0-2 (2 - biegunowy)

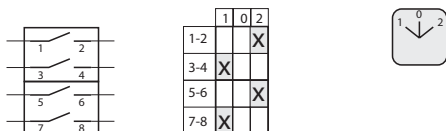

### 3.4315 Rozł cznik 1-0-2 (3 - biegunowy)

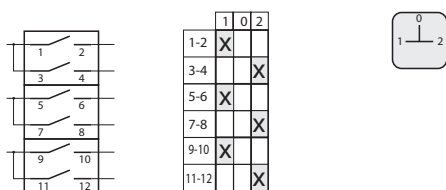

### 3.8380 Rozł cznik 1-0-2 (3 - biegunowy)

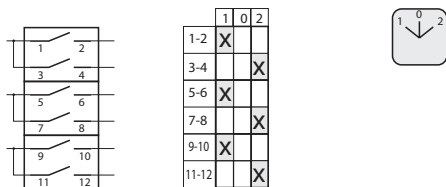

### 4.8396 Rozł cznik 1-0-2 (4 - biegunowy)

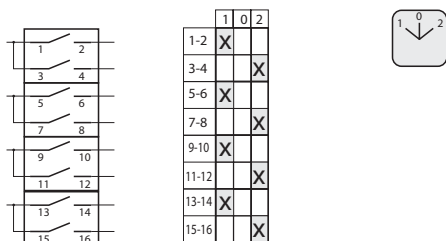

### 5.8380 Rozł cznik 1-0-2 (5 - biegunowy)

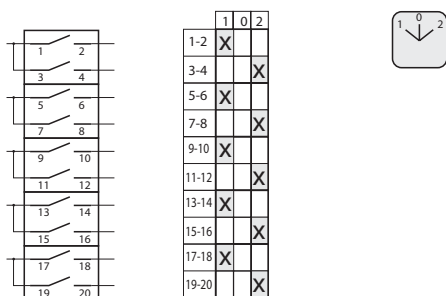

### 6.8380 Rozł cznik 1-0-2 (6 - biegunowy)

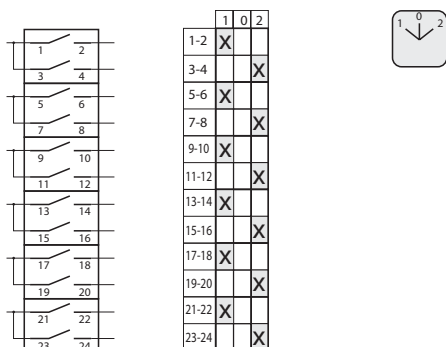

### 8.8380 Rozł cznik 1-0-2 (8 - biegunowy)

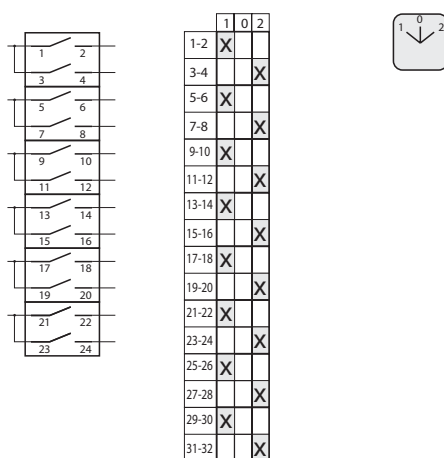

### 9.8380 Rozł cznik 1-0-2 (9 - biegunowy)

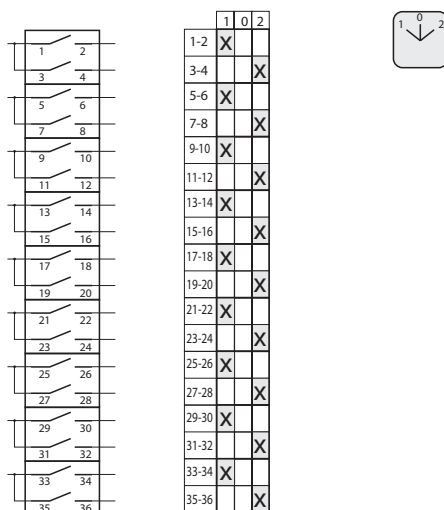



**6.4490** Przeł. cznik Dahlander'a trójbiegowy pojedyncze uzwojenie dla wysokich obrotów

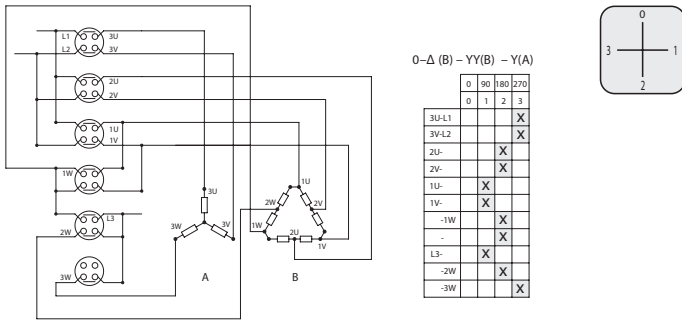

Ł czniki obwodów 0 - 1 - 2 - 3

**2.8445** Ł cznik obwodów 0-1-2-3

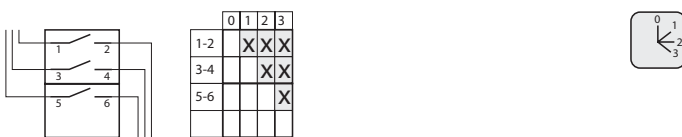

Rozł czniki obrotowe 0 - 1

**2.4414** Rozł cznik obrotowy 0-1

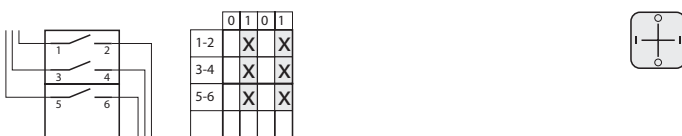

Rozł czniki główne

**2.421** Rozł cznik główny

